

ES96-24UD

Class 2 Electronic UNIV 5 in 1 dimming

Plastic Suitable For Dry And Damp Location Enclosure

Single Circuit: **24VDC 20kHz PWM**

Total Wattage: **96W max**

Input Voltage: **100-277V 50/60Hz**



Conforms to UL STD. 8750 and 1310
Certified to CSA
STD. C22.2 No 250.0

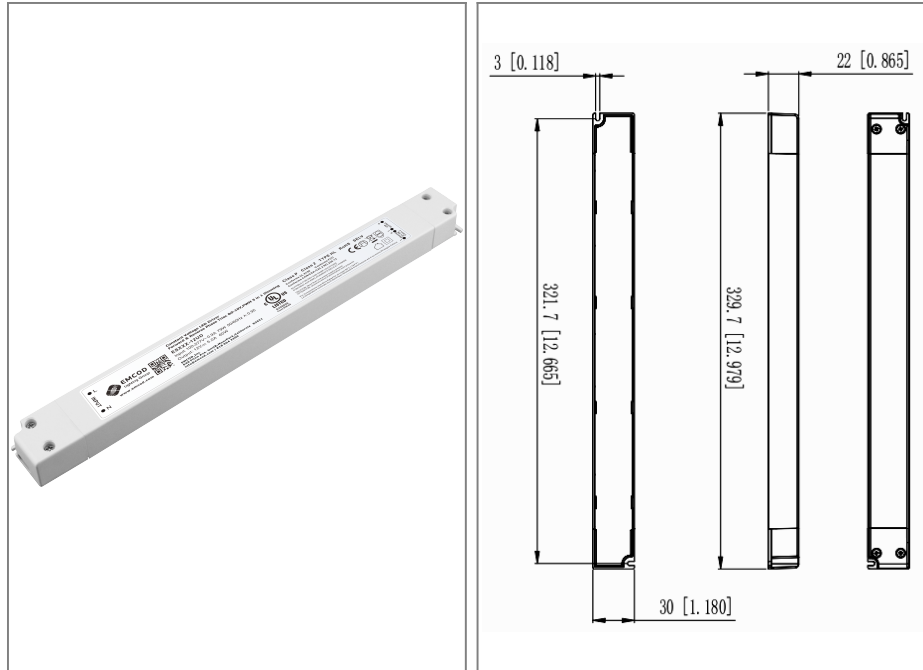

Transformer

Dimmable with triac forward and reverse phase, 0/1-10V , resistor, PWM

Input leads: Terminal Block

Output leads: Terminal Block

Housing

The actual transformer 96W is encapsulated in the enclosure

The enclosure is Plastic suitable for dry and damp location, with wire compartment, IP 20 rated

Enclosure Temperature does not exceed 65°C at 45°C ambient and fully loaded

Dimensions (inch): H = 12.7, W = 1.18, D = 0.85

Weight (LBs): 0.7

Electrical Parameters

Input Voltage: **100-277V 50/60Hz**

Max. input current at full load: **1.3A**

Output voltage without load: **24.1VDC**

Output voltage fully loaded: **24VDC**

Max. Total Wattage: **96W**

Max. Output Current: **4A**

Efficiency: **85%**

Load regulation: **0.5%**

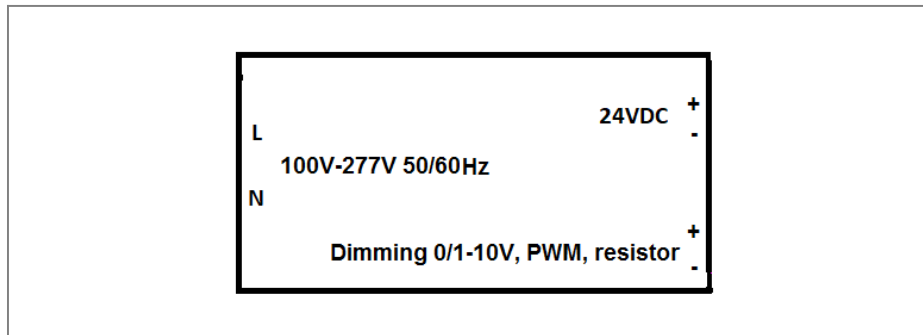

Mailing Address: 646 Flinn Ave. Unit B, Moorpark , CA 93021 Tech support: Arik Nirenberg phone: 818-904-3309

Fax: 818 904 3327 info@emcod.com techsupport@emcod.com