

EMS200S12AC

Magnetic

Outdoor Stainless Steel Enclosure

Single Circuit: **12VAC**

Total Wattage: **200W max**

Input Voltage: **120V 60Hz**



Conforms to UL STD. 2108
Certified to CSA
STD. C22.2 No 250.0
model EM150
[Link to certification](#)

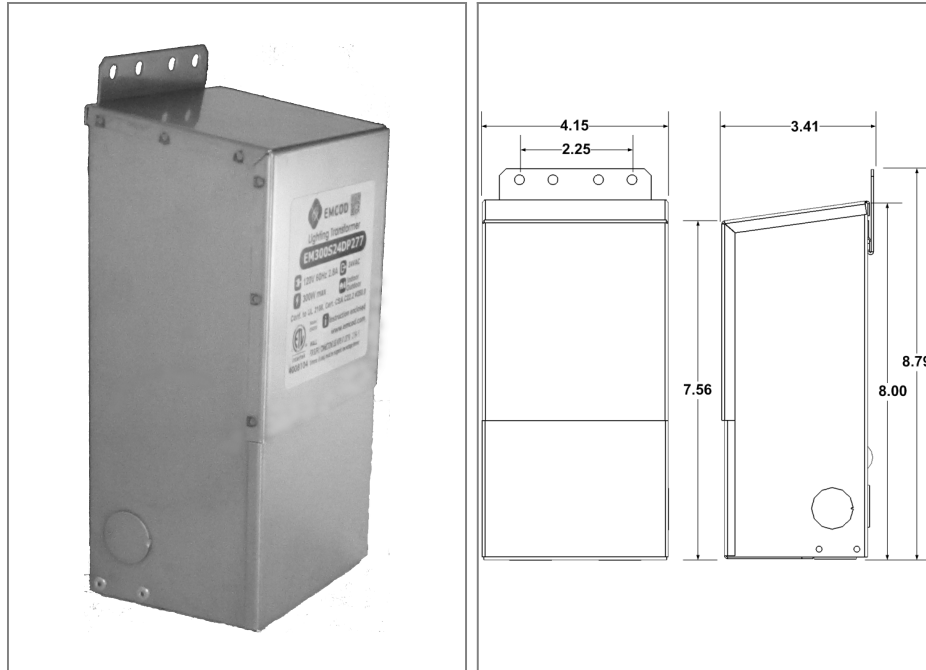

Transformer

Temperature class B(130°C)

Two section bobbin completely separated primary and secondary windings

Input leads are 18AWG 600V

Output leads are 12AWG 300V

Leads max. operational temperature is 105°C

Thermal manually reset primary breaker 3A

Thermal manually reset secondary breaker 25A

Housing

The actual transformer 200W is encapsulated in the enclosure

The enclosure is Stainless Steel, NEMA 3R rated

Wiring compartment has 6 knockouts sizes for 3/8 inch screw cable connectors

Enclosure Temperature does not exceed 75°C at 45°C ambient and fully loaded

Dimensions (inch): H = 8, W = 4.15, D = 3.41

Weight (LBs): 0.6

Electrical Parameters

Input Voltage: **120V 60Hz**

Max. input current at full load: **1.7A**

Output voltage without load: **12.8VAC**

Output voltage fully loaded: **11.8VAC**

Max. Total Wattage: **200W**

Max. Output Current: **16.7A**

Efficiency: **85%**

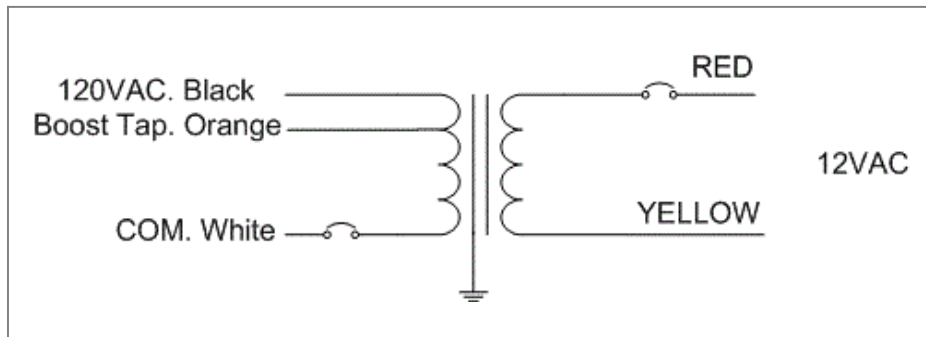

Mailing Address: 646 Flinn Ave. Unit B, Moorpark , CA 93021 Tech support: Arik Nirenberg phone: 818-904-3309

Fax: 818 904 3327 info@emcod.com techsupport@emcod.com