

## ML60S24DC277

### Class 2 Magnetic

Outdoor Black Powder Coated Steel Enclosure

Single Circuit: **24VDC**

Total Wattage: **60W max**

Input Voltage: **277V 60Hz**



Conforms to UL STD. 1310  
Certified to CSA  
STD. C22.2 No 223  
model EM60  
[Link to certification](#)

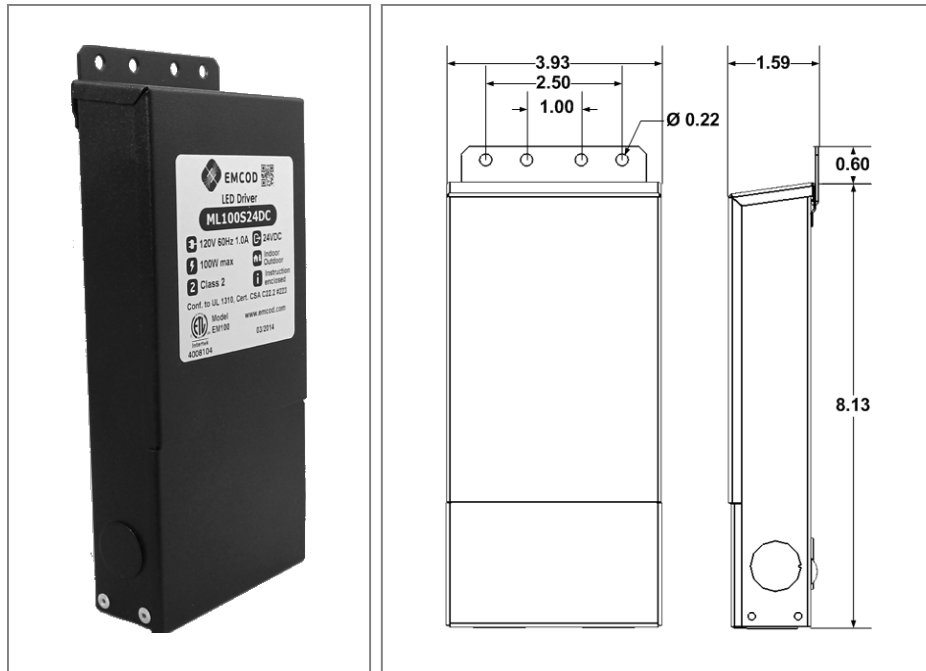

### Transformer

Temperature class B(130°C)

Input leads are 18AWG 600V

Output leads are 18AWG 300V

Leads max. operational temperature is 105°C

Thermal manually reset secondary breaker 4A

### Housing

The actual transformer 60W is encapsulated in the enclosure

The enclosure is Black Powder Coated Steel, NEMA 3R rated

Wiring compartment has 6 knockouts sizes for 3/8 inch screw cable connectors

Enclosure Temperature does not exceed 75°C at 45°C ambient and fully loaded

Dimensions (inch): H = 8.13, W = 3.93, D = 1.59

Weight (LBs): 0.4

### Electrical Parameters

Input Voltage: **277V 60Hz**

Max. input current at full load: **0.6A**

Output voltage without load: **27.2VDC**

Output voltage fully loaded: **23.5VDC**

Max. Total Wattage: **60W**

Max. Output Current: **2.5A**

Efficiency: **85%**

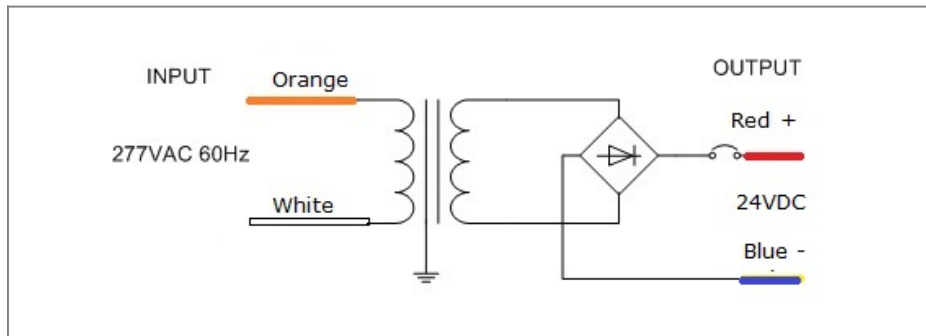

Mailing Address: 646 Flinn Ave. Unit B, Moorpark , CA 93021 Tech support: Arik Nirenberg phone: 818-904-3309

Fax: 818 904 3327 info@emcod.com techsupport@emcod.com