

MLE80-12DC-UD T24

Electronic UNIV 5 in 1 dimming

Outdoor Black Powder Coated Steel Enclosure

Single Circuit: **12VDC**

Total Wattage: **80W max**

Input Voltage: **100-277V 50/60Hz**



Conforms to UL STD. 8750 and 1310
Certified to CSA
STD. C22.2 No 250.0
model MLE80-12DC-UD

Installation Instruction



- * Read instruction completely before installation.
- * Turn off electricity before wiring.
- * Only qualified personal should install the unit
- * Installation must comply with the NEC.
- * Ensure the unit has input, output voltage and output wattage proper for your application.

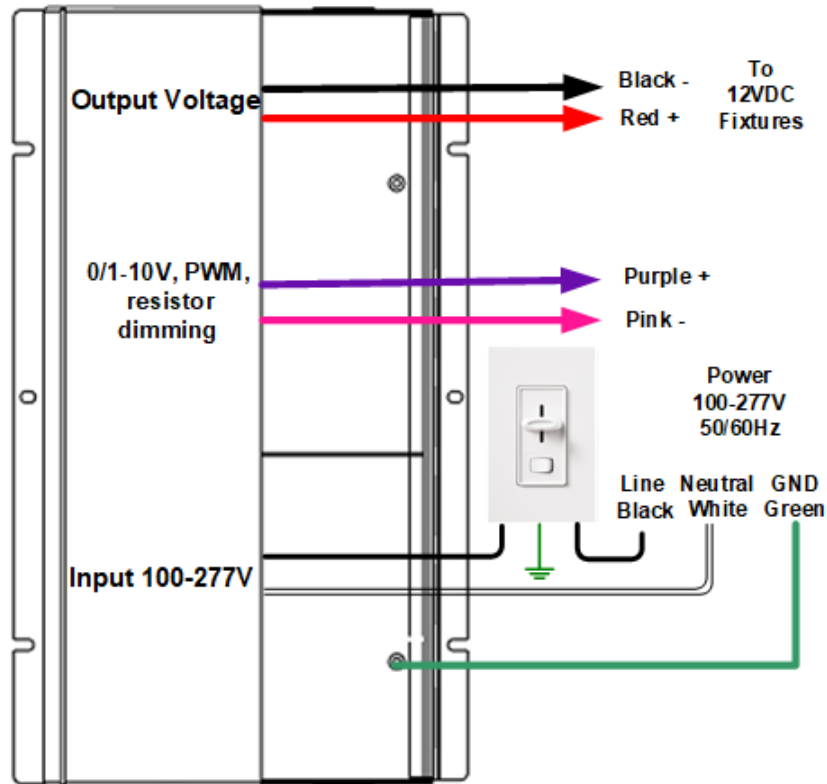

Mounting

The transformer must be mounted in at least 5" of a free flow air space for proper ventilation.

The transformer must never be mounted next to or above heat radiated objects.

The maximum ambient temperature should not exceed 45 deg. C (115 deg. F) at full load.

Connection

Open the wire compartment and remove knockouts for input and output, install strain reliefs (wire clamps). Use only right size and UL approved wire nuts.

Input Connection

Bring your line and neutral wires through input strain relief and connect them to the Black and White transformers leads.

Dimming Connection

If you are going to use Phase cut (Triac) dimmer, connect it as on the diagram. If you going to use 0/1-10V, PWM dimmer or resistor, connect it to Purple + and Pink -.

Output Connection

Bring your lights wires through output strain relief and connect to the Red + and Black - transformer's leads. Make sure all your connection very tight

Grounding

The LED Driver is grounded to the enclosure. The enclosure in turn should be grounded in accordance with NEC and local code. Connect the transformer green wire to the ground.

Mailing Address: 646 Flinn Ave. Unit B, Moorpark , CA 93021 Tech support: Arik Nirenberg phone: 818-904-3309

Fax: 818 904 3327 info@emcod.com techsupport@emcod.com