

## MLE30-24DC-UD T24

Class 2 Electronic UNIV 5 in 1 dimming

Outdoor Black Powder Coated Steel Enclosure

Single Circuit: **24VDC**

Total Wattage: **30W max**

Input Voltage: **100-277V 50/60Hz**



Conforms to UL STD. 8750 and 1310  
Certified to CSA  
STD. C22.2 No 250.0  
model MLE30-24DC-UD

### Installation Instruction



- \* Read instruction completely before installation.
- \* Turn off electricity before wiring.
- \* Only qualified personal s should install the unit
- \* Installation must comply with the NEC.
- \* Ensure the unit has input, output voltage and output wattage proper for your application.

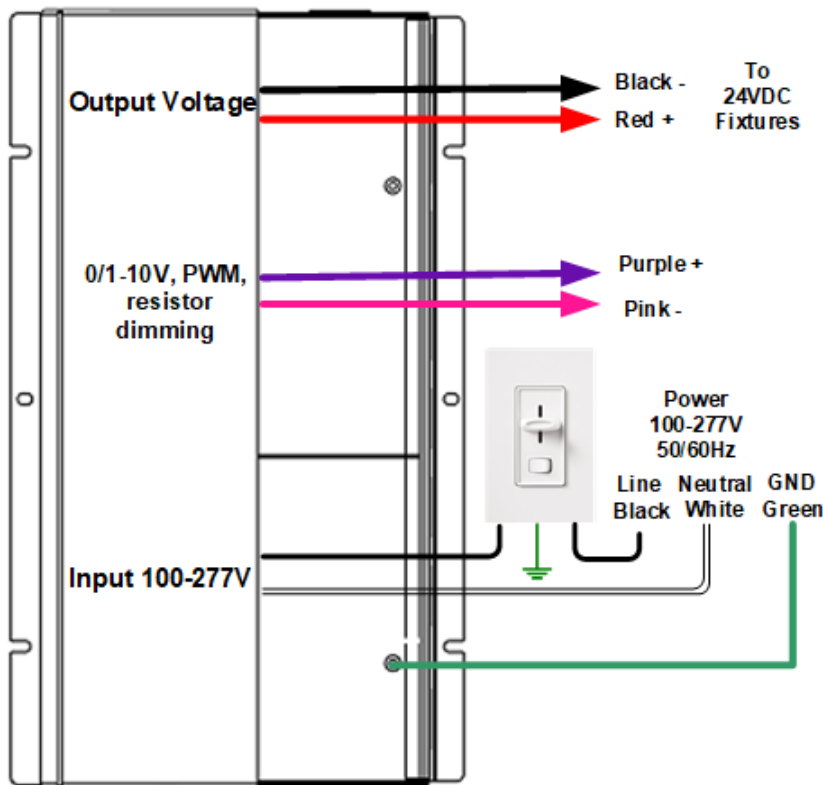

#### Mounting

The transformer must be mounted in at least 5" of a free flow air space for proper ventilation.

The transformer must never be mounted next to or above heat radiated objects.

The maximum ambient temperature should not exceed 45 deg. C (115 deg. F) at full load.

#### Connection

Open the wire compartment and remove knockouts for input and output, install strain reliefs (wire clamps). Use only right size and UL approved wire nuts.

#### Input Connection

Bring your line and neutral wires through input strain relief and connect them to the Black and White transformer's leads.

#### Dimming Connection

If you are going to use Phase cut (Triac) dimmer, connect it as on the diagram. If you going to use 0/1-10V, PWM dimmer or resistor, connect it to Purple + and Pink -.

#### Output Connection

Bring your lights wires through output strain relief and connect to the Red + and Black - transformer's leads. Make sure all your connection very tight

#### Grounding

The LED Driver is grounded to the enclosure. The enclosure in turn s should be grounded in accordance with NEC and local code. Connect the transformer green wire to the ground.

Mailing Address: 646 Flinn Ave. Unit B, Moorpark , CA 93021 Tech support: Arik Nirenberg phone: 818-904-3309

Fax: 818 904 3327 [info@emcod.com](mailto:info@emcod.com) [techsupport@emcod.com](mailto:techsupport@emcod.com)