

MLE300-24DC-UD T24

Electronic UNIV 5 in 1 dimming

Outdoor Black Powder Coated Steel Enclosure

Single Circuit: **24VDC 4kHz PWM, T24 JA-8**

Total Wattage: **300W max**

Input Voltage: **100-277V 50/60Hz**



Conforms to UL STD. 8750 and 1310
Certified to CSA
STD. C22.2 No 250.0
model MLE300-24DC-UD

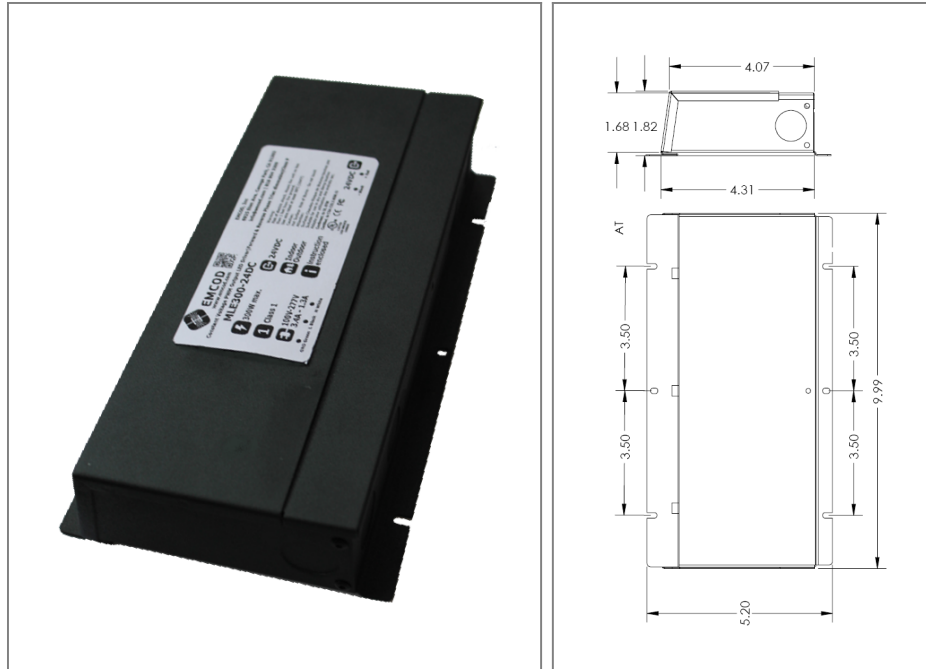

Transformer

Dimmable with triac forward and reverse phase, 0/1-10V , resistor, PWM

Input leads are 18AWG 600V

Output leads are 16AWG 300V

Leads max. operational temperature is 105°C

Housing

The actual transformer 300W is encapsulated in the enclosure

The enclosure is Black Powder Coated Steel, NEMA 3R rated

Wiring compartment has 6 knockouts sizes for 3/8 inch screw cable connectors

Working ambient temperature range: -40°C (-40°F) to 60°C (140°F)

Enclosure Temperature does not exceed 70°C at 45°C ambient and fully loaded

Dimensions (inch): H = 5.2, W = 9.99, D = 1.82

Weight (LBs): 3

Electrical Parameters

Input Voltage: **100-277V 50/60Hz**

Max. input current at full load: **3A**

Output voltage without load: **24.1VDC**

Output voltage fully loaded: **24VDC**

Max. Total Wattage: **300W**

Max. Output Current: **12.5A**

Efficiency: **87%**

Load regulation: **1%**

Ripple: **5%**

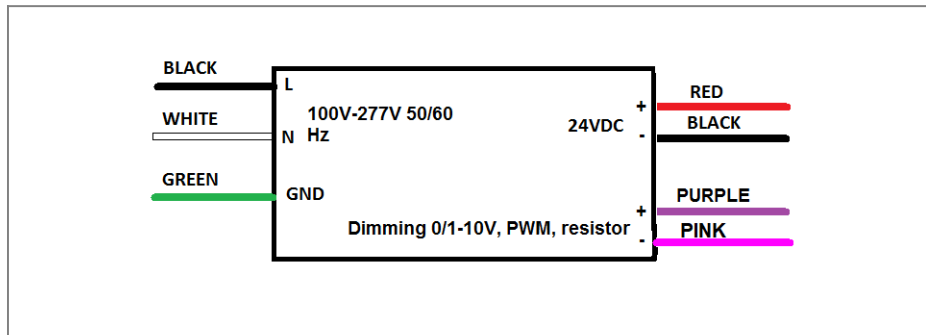

Mailing Address: 646 Flinn Ave. Unit B, Moorpark , CA 93021 Tech support: Arik Nirenberg phone: 818-904-3309

Fax: 818 904 3327 info@emcod.com techsupport@emcod.com