

ECV200-12DC

Electronic Dimmable

Outdoor Aluminum With Wire Compartment Enclosure

Single Circuit: **12VDC**

Total Wattage: **200W max**

Input Voltage: **120V 50/60Hz**



Conforms to UL STD. 1012
Certified to CSA
STD. C22.2 № 107.1

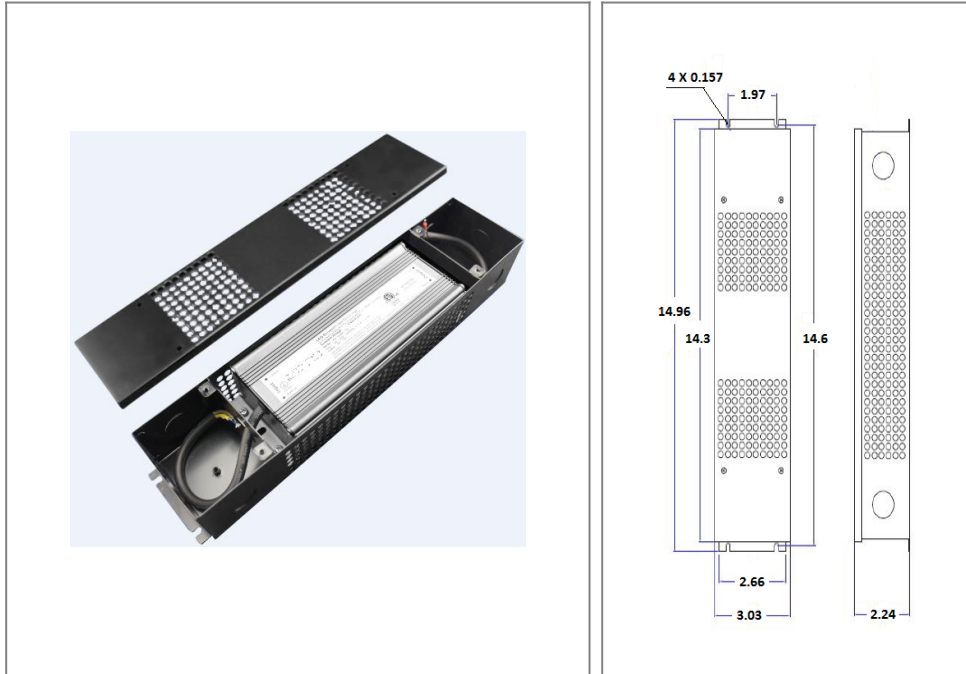

Transformer

Dimmable with any EV, MLV, CL, forward or revers phase.
Input leads are 18AWG 600V
Output leads are 18AWG 300V
Leads max. operational temperature is 105°C

Housing

The actual transformer 200W is encapsulated in the enclosure
The enclosure is Aluminum with wire compartment, IP 67 rated
Wiring compartment has 4 knockouts sizes for 3/8 inch screw cable connectors
Enclosure Temperature does not exceed 70°C at 45°C ambient and fully loaded
Dimensions (inch): H = 14.3, W = 3.03, D = 2.24
Weight (LBs): 4

Electrical Parameters

Input Voltage:	120V 50/60Hz
Max. input current at full load:	3.6A
Output voltage without load:	12.2VDC
Output voltage fully loaded:	12VDC
Max. Total Wattage:	200W
Max. Output Current:	16.7A
Efficiency:	85%
Load regulation:	1%
Ripple:	10%

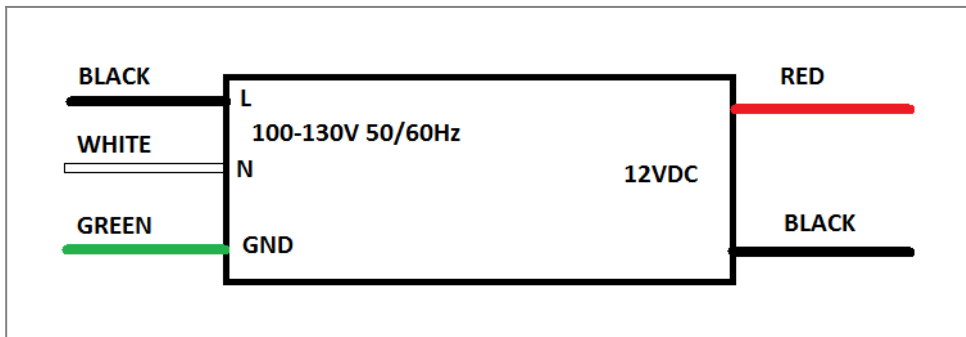

Mailing Address: 15545 Cabrito Rd. Van Nuys, CA 91406 Tech support: Arik Nirenberg phone: 818-904-3309 cellphone: 818-269-4091
Fax: 818 904 3327 info@emcod.com techsupport@emcod.com