

ML10S24DC277

Class 2 Magnetic Phase cut Dimmable

Outdoor Black Powder Coated Steel Enclosure

Single Circuit: **24VDC**

Total Wattage: **10W max**

Input Voltage: **277V 60Hz**



Conforms to UL STD. 1310
Certified to CSA
STD. C22.2 No 223
model EM10
[Link to certification](#)

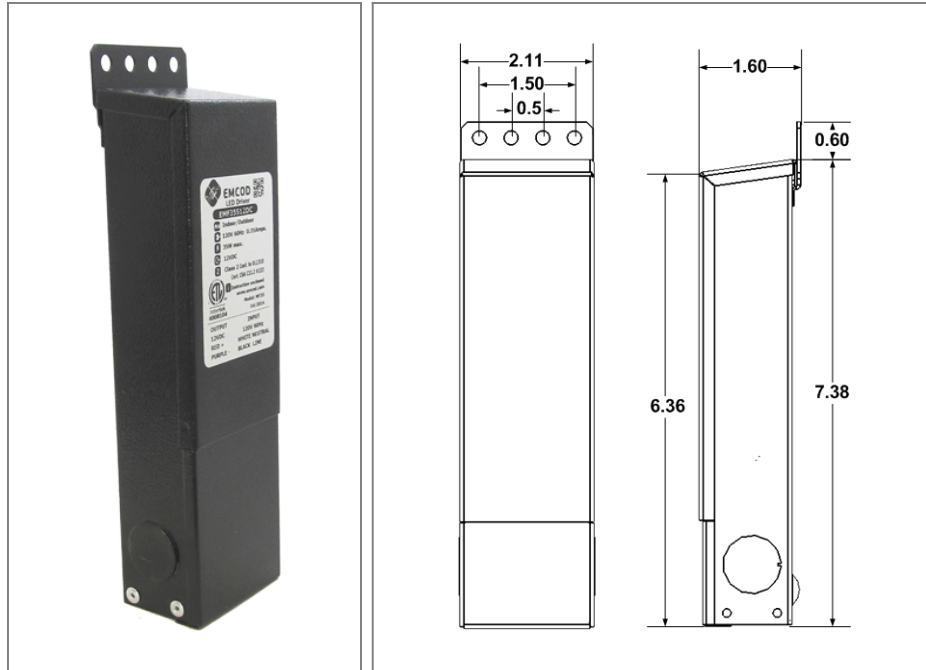

Transformer

Dimmable with compatible MLV, ELV, CL dimmers, please refer to list on emcod.com

Temperature class B(130°C)

Input leads are 18AWG 600V

Output leads are 18AWG 300V

Leads max. operational temperature is 105°C

Thermal self reset secondary breaker 0.8A

Housing

The actual transformer 10W is encapsulated in the enclosure

The enclosure is Black Powder Coated Steel, NEMA 3R rated

Wiring compartment has 2 knockouts sizes for 3/8 inch screw cable connectors

Enclosure Temperature does not exceed 65°C at 45°C ambient and fully loaded

Dimensions (inch): H = 7, W = 2.11, D = 1.54

Weight (LBs): 1.5

Electrical Parameters

Input Voltage: **277V 60Hz**

Max. input current at full load: **0.04A**

Output voltage without load: **26VDC**

Output voltage fully loaded: **23.5VDC**

Max. Total Wattage: **10W**

Max. Output Current: **0.4A**

Efficiency: **85%**

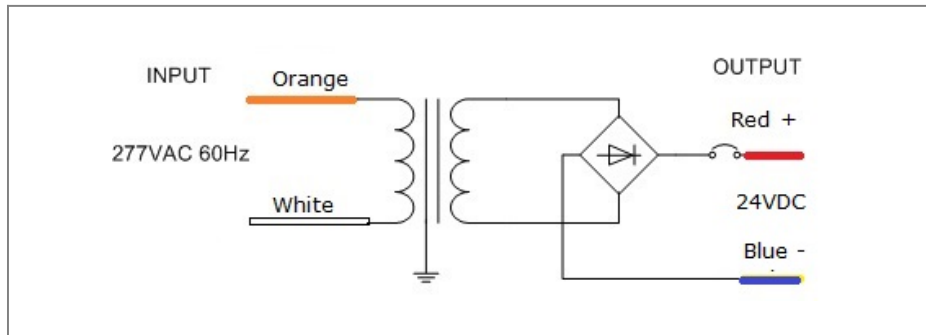

Mailing Address: 646 Flinn Ave. Unit B, Moorpark, CA 93021 Tech support: Arik Nirenberg phone: 818-904-3309
Fax: 818 904 3327 info@emcod.com techsupport@emcod.com