

EMF5S24VDC

Class 2 Magnetic Dimmable

Outdoor Black Powder Coated Steel Enclosure

Single Circuit: **24VDC**

Total Wattage: **5W max**

Input Voltage: **120V 60Hz**



Conforms to UL STD. 1310
Certified to CSA
STD. C22.2 No 223
model EM5
[Link to certification](#)

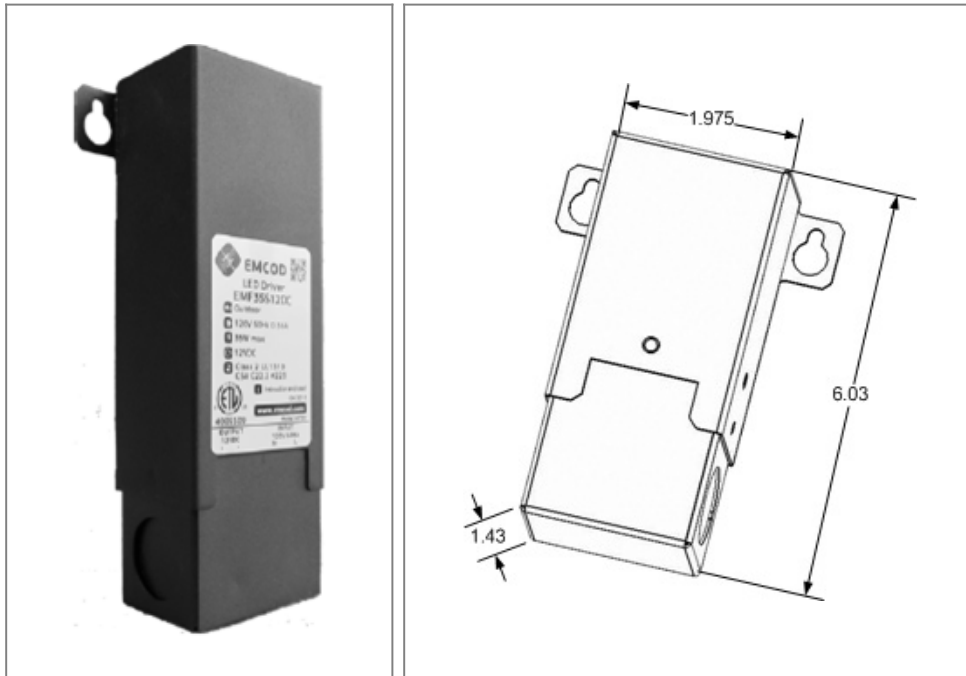

Transformer

Dimmable with any LV magnetic dimmer as long as you cover dimmer's min load.

Temperature class B(130°C)

Input leads: Terminal Block

Output leads: Terminal Block

Thermal self reset primary breaker 0.8A

Thermal self reset secondary breaker 0.8A

Housing

The actual transformer 5W is encapsulated in the enclosure

The enclosure is Black Powder Coated Steel, NEMA 3R rated

Wiring compartment has 2 knockouts sizes for 3/8 inch screw cable connectors

Enclosure Temperature does not exceed 65°C at 45°C ambient and fully loaded

Dimensions (inch): H = 6.03, W = 1.97, D = 1.43

Electrical Parameters

Input Voltage: **120V 60Hz**

Max. input current at full load: **0.05A**

Output voltage without load: **28VDC**

Output voltage fully loaded: **23.5VDC**

Max. Total Wattage: **5W**

Max. Output Current: **0.2A**

Efficiency: **83%**

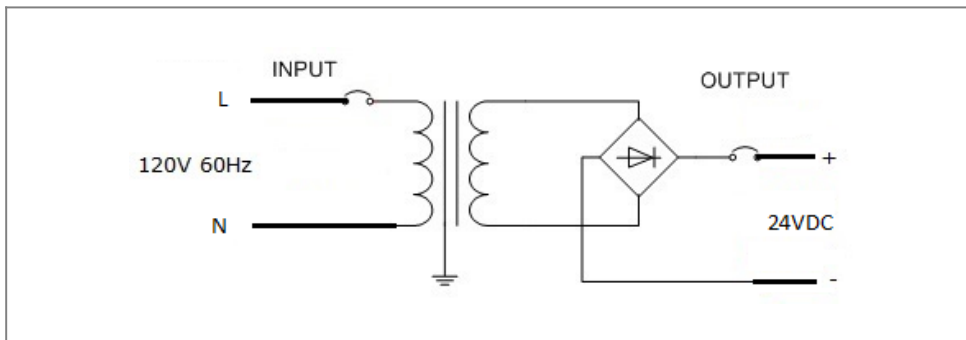

Mailing Address: 6925 Eton Ave. Canoga Park, CA 91303 Tech support: Arik Nirenberg phone: 818-904-3309 cellphone: 818-269-4091
Fax: 818 904 3327 info@emcod.com techsupport@emcod.com